

The Scala Miniflector® is a medium-gain half-parabolic antenna designed for fixed-station radio systems.

- Heavy-duty construction of anodized aluminum pipe, tubing and castings plus stainless steel hardware and fastenings for corrosion resistance.
- The Feed assembly is foam-potted and sealed for maximum reliability in severe environments.



Specifications	
Frequency range	890—960 MHz
Gain	14 dBd (16.15 dBi)
Impedance	50 ohms
VSWR	<1.5:1
Polarization	Vertical
Front-to-back ratio	>23 dB
Maximum input power	100 watts (at 50°C)
H-plane beamwidth	16 degrees (half-power)
E-plane beamwidth	34 degrees (half-power)
Connector	N female
Weight	13 lb (5.9 kg)
Dimensions	44.9 x 17.8 x 16.8 inches (1140 x 451 x 428 mm)
Wind load at 93 mph (150 kph)	
Front / side	50 lbf / 28 lbf (222 N) / (121 N)
Wind survival rating*	120 mph (200 kph)
Shipping dimensions	47 x 18.5 x 16.5 inches (1194 x 470 x 419 mm)
Shipping weight	20 lb (9.1 kg)
Mounting	Mounting kits available for masts of 2.375 to 4.5 inch (60 to 114 mm) OD.

* Mechanical design is based on environmental conditions as stipulated in TIA-222-G-2 (December 2009) and/or ETS 300 019-1-4 which include the static mechanical load imposed on an antenna by wind at maximum velocity. Contact KBU for further details.

MINIFLECTOR is a registered trademark of Kathrein Broadcast USA.

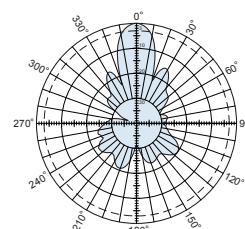

H-plane
Horizontal pattern — V-polarization

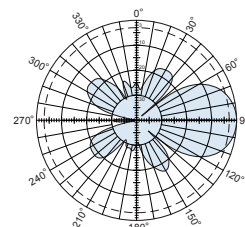

E-plane
Vertical pattern — V-polarization

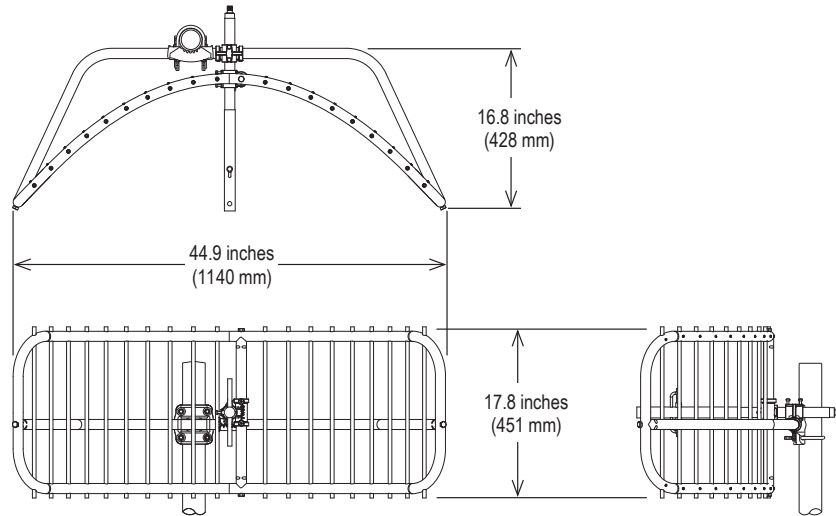

Miniflector Screen Dimensions

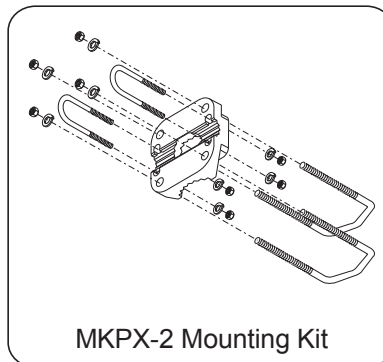

MKPX-2 Mounting Kit

Mounting options

Model	Description
MKPX-2	Mounting kit for 2.375 inch (60 mm) OD mast
MKPX-3	Mounting kit for 2.875 inch (73 mm) OD mast
MKPX-4	Mounting kit for 3.5 inch (89 mm) OD mast
MKPX-5	Mounting kit for 4 inch (102 mm) OD mast
MKPX-6	Mounting kit for 4.5 inch (114 mm) OD mast

30007a subject to alteration